



Global Supplier EDI Specifications

Despatch Advice

DESADV

EDIFACT DESADV D.97A

Nexteer Version 2.7

DOCUMENT CHANGE LOG

Version	Date	Description
1.0	2012.05.11	Document issued.
1.1	2012.07.23	Removed Requirement for GIR segment 0630
1.2	2012.10.09	Changes to NAD+SU to be DUNS number for supplier
2.0	2013.08.11	Added Mandatory Pro Number to RFF Segment 1. Highlighted the QTY Unit of Measure must return what was sent on the DELFOR/DELJIT. Listed Allowable Unit of Measure in MEA segments.
2.1	2013.09.13	Added notation to LIN segment that an item number can NOT be entered more than once on a single ASN. Made changes to examples for all unit of measures to show PC instead of C62.
2.2	2013.09.23	RFF segment removed the line item number not required as it is not sent on the DELFOR or DELJIT
2.3	2013.09.24	Added notation that the ASN ID Number in the BGM segment and the packing slip number in the RFF MB segment must be the same.
2.4	2013.10.10	Added Heat code/Lot Number to PIA segment as optional
2.5	2015.06.30	Adding Post Mexico go-live modifications. Adding Mexico DESADV example.
2.6	2018-02-23	Adding ASN number must equal packing list number.
2.7	2019-03-05	Adding new requirements for the RFF:CN Pro #.

0. TABLE OF CONTENT

0. TABLE OF CONTENT 3

1. INTRODUCTION 4

2. MESSAGE DEFINITION 4

2.1. FUNCTIONAL DEFINITION 4

2.2. PRINCIPLES 4

2.3. REFERENCES 5

2.4. FIELD OF APPLICATION 5

3. MESSAGE DESCRIPTION 5

3.1. INTRODUCTION 5

3.1.1. How to read the documentation 5

3.1.2. General remarks	7
3.2. SEGMENT TABLE	7
3.3. BRANCHING DIAGRAM	9
3.4. MESSAGE STANDARD DESCRIPTION.....	12
3.5. MESSAGE STRUCTURE	17
3.6. SERVICE SEGMENTS DESCRIPTION	17
3.7. DATA SEGMENTS DESCRIPTION	22

1. INTRODUCTION

This document provides the specific description of a subset of the EDIFACT DESADV D97.A message to be used between a Trading Partner and Nexteer.

2. MESSAGE DEFINITION

This document provides the definition of an Advanced Shipping Notification (ASN) or Despatch Advice Message, based on the EDIFACT DESADV D97.A, to be used in Electronic Data Interchange (EDI) between a Trading Partner and Nexteer.

This documentation is fully comprehensive and allows the implementation of the EDIFACT DESADV without the necessity for any additional standard related documentation.

2.1. FUNCTIONAL DEFINITION

The ASN/Despatch Advice message is a message from a Nexteer Supplier to the relevant Nexteer application. It gives information concerning material despatched to a Nexteer location as instructed by a previously received Delivery Instruction or Shipping Schedule message and in line with the conditions set out in the contract or order.

2.2. PRINCIPLES

The ASN/Despatch Advice message intends to:

- advise the recipient (Consignee) of the despatch of goods and to provide the details regarding the content of the consignment.
- allow the recipient (Consignee) to track material shipments and to prepare the physical receipt of the consignment.

An ASN/Despatch Advice message can relate to:

- different articles which may be packed differently (as instructed or agreed).
- articles covered by different Delivery Instruction and/or Stock Status messages.

The ASN/Despatch Advice message must always include the transportation information (e.g., weight, means of transport, etc.) related to the load advised.

As the information transmitted in the ASN/Despatch Advice is vital to ensure an efficient receipt of the material at the receiving plant and since, whenever a Consolidator is involved, this information needs to be consolidated with other messages. **Therefore it is mandatory that the ASN/Despatch Advice is sent immediately after the departure of the material.**

2.3. REFERENCES

The content of this message is based on:

- the message structure as defined by EDIFACT for the UNSM Despatch Advice Message DESADV as published in the UN/EDIFACT D97.A Directory.
- the agreement between the Trading Partners on the data elements to be used, their unique definition, their representation and their values (coded or clear form) as identified in this document.

Nexteer has opted for the EDIFACT D97.A Directory and consistently uses this directory for all its EDIFACT messages. Although the AVIEXP subset defined by ODETTE has been based on the EDIFACT D96.A Directory, the subset defined by Nexteer and described in this document follows as close as possible the structure of the ODETTE subset.

2.4. FIELD OF APPLICATION

The following definition of an ASN/Despatch Advice Message in EDIFACT format is applicable for the interchange of shipping instructions issued by Nexteer for material deliveries to one or more Nexteer operations.

3. MESSAGE DESCRIPTION

Following pages contain a full description of the EDIFACT DESADV D97.A message as implemented by Nexteer. All segments are included regardless whether used or not used in the interchange with Nexteer. The official EDIFACT segment description is complemented with remarks pertaining to the specific requirements for an interchange with Nexteer. Those remarks contain specific code values used, additional information on the values shown in a specific field, etc.

3.1. INTRODUCTION

3.1.1. How to read the documentation

All segments in the subset used by Nexteer are described in the following pages. The segment description is to be read as follows:

①	0020	BGM - BEGINNING OF MESSAGE		
②	Segment group:	none.	Level:	1.
③	EDIFACT status:	mandatory.	Nexteer status:	mandatory.
④	Maximum use:	1 per message.	Nexteer occurrences:	1 per message.
⑤	Function:	Segment for the unique identification of the delivery schedule document, by means of its name and its number.		
⑥	Nexteer	see remarks. interchange:		
⑦	Example:	BGM++123456+9' A B		
		“+” separates segment sections; “:” separates elements within a segment section		

EDIFACT STANDARD DEFINITION						Nexteer IMPLEMENTATION			
REF	TAG	NAME	ST	FT	SP	ST	FT	REMARKS	
9	C002	<i>DOCUMENT/MESSAGE NAME</i>	C						
	1001	Document/message name, coded	C	an..3	:				
	1131	Code list qualifier	C	an..3	:				
	3055	Code list responsible agency, coded	C	an..3	:				
	1000	Document/message name	C	an..35	+				
A	C106	<i>DOCUMENT/MESSAGE IDENTIFICATION</i>	C			M			
	1004	Document/message number	C	an..35	:	M	an..10	A unique control number, commonly called a Shipment Identification Number (SID), assigned by the original shipper to identify a specific shipment. This unique control number cannot be repeated within a one-year period. This number must be the same as the packing slip/master bill of lading. The SID number will be used by NEXTEER as the reference number on the payment remittance to the supplier.	
	1056	Version	C	an..9					
	1060	Revision number	C	an..6	+				
B	1225	MESSAGE FUNCTION, CODED	C	an..3	+	M	an..3	Function of the message. For code values see below. Note: "9" is currently the only code which Nexteer will automatically process.	
	4343	RESPONSE TYPE, CODED	C	an..3	'				

COMMENTS

10

CODE VALUES

LEGEND

- 1 segment position in the message structure, segment tag and segment name.
- 2 identification (when applicable) of the segment group in which the segment is situated and indication at which level the segment is in the message.
- 3 status of the segment: as defined by EDIFACT and by Nexteer.
- 4 number of occurrences of the segment: as defined by EDIFACT and as used by Nexteer.
- 5 description of the function of the segment as defined by EDIFACT and as used by Nexteer.
- 6 example of the segment as it may appear in an interchange. This example is only illustrative and does not necessarily represent an actual situation. It should **NOT** be used as a basis to implement this message.
- 7 definition of the segment content as defined by EDIFACT and as implemented by Nexteer.
- 8 identification of the data elements in the segment □
reference to the example.
 - data element tag - data elements with a 'C' denote a composite data element. □
data element name - *italic CAPITALS* denote a composite data element.
 - **ST** - the status of the data element.
 - **FT** - the format of the data element, i.e. the indication of the number of characters (numerical or alphabetical) for this data element.
 - **SP** - the separator used between the data elements.
 - remarks on the specific use of the data element in the interchange with Nexteer.
- 9 Shaded areas in the Nexteer description mean that Nexteer does not use the data elements.
- 10 the segment description can be followed by:
 - comments providing more information regarding specific data elements and how they must be used and/or understood in messages from Nexteer.
 - code values to be used for data elements contained in the message.

3.1.2. General remarks

Following remarks are applicable for the complete documentation:

Dates

Unless otherwise specified in the field explanation in the documentation, dates are always expressed as **CCYYMMDD** (qualifier 2379 = 102).

Times

Unless otherwise specified in the field explanation in the documentation, times are always expressed as **HHMM**.

Nexteer Status

Mandatory: All data elements Marked “Mandatory” should be returned in the DESADV

Conditional: All data elements Marked “Conditional” should be returned in DESADV if sent in the DELJIT / based on some conditions.

Optional: All data elements marked “Optional” may/may not be returned in the DESADV

3.2. SEGMENT TABLE

The following table shows the segments defined for the EDIFACT UNSM DESADV D97.A Despatch Advice message. Shaded areas identify the segments that are not used in the subset of DESADV used by Nexteer. This table, which should be read in conjunction with the branching diagram indicates the maximum number of occurrences for each segment.

POS.	TAG	NAME	ST	REPEATS
0010	UNH	Message header	M	1
0020	BGM	Beginning of message	M	1
0030	DTM	Date/time/period	C	10
0040	ALI	Additional information	C	5
0050	MEA	Measurements	C	5
0060	MOA	Monetary amount	C	5
0070				
Segment group 1			C	10

0080	RFF	Reference	M	1
0090	DTM	Date/time/period	C	1
0100	Segment group 2		C	10
0110	NAD	Name and address	M	1
0120	LOC	Place/location identification	C	10
0130	Segment group 3		C	10
0140	RFF	Reference	M	1
0150	DTM	Date/time/period	C	1
0160	Segment group 4		C	10
0170	CTA	Contact information	M	1
0180	COM	Communication contact	C	5
0190	Segment group 5		M	10
0200	TOD	Terms of delivery or transport	M	1
0210	LOC	Place/location identification	C	5
0220	FTX	Free text	C	5
0230	Segment group 6		C	10
0240	TDT	Details of transport	M	1
0250	PCD	Percentage details	C	6
0260	Segment group 7		C	10
0270	LOC	Place/location identification	M	1
0280	DTM	Date/time/period	C	10
0290	Segment group 8		C	10
0300	EQD	Equipment details	M	1
0310	MEA	Measurements	C	5

0320	SEL	Seal number	C	25
	EQA	Attached equipment	C	5
0330				
0340				
Segment group 9			M	10
0350	HAN	Handling instructions	M	1
0360	FTX	Free text	C	10

POS.	TAG	NAME	ST	REPEATS
0370				
Segment group 10			C	499
0380	CPS	Consignment packing sequence	M	1
0390	FTX	Free text	C	5
0400				
Segment group 11			C	9999
0410	PAC	Package	M	1
0420	MEA	Measurements	C	10
0430	QTY	Quantity	C	10
0440				
Segment group 12			C	10
0450	HAN	Handling instructions	M	1
0460	FTX	Free text	C	10
0470				
Segment group 13			M	1000
0480	PCI	Package identification	M	1
0490	RFF	Reference	C	1
0500	DTM	Date/time/period	C	5
	GIR	Related identification numbers	M	99
0510				
0520				
Segment group 14			C	99
0530	GIN	Goods identity number	M	1
0540	DLM	Delivery limitations	C	10
0550				
Segment group 15			C	499
0560	LIN	Line item	M	1
0570	PIA	Additional product id.	M	10
0580	IMD	Item description	C	25
0590	MEA	Monetary amount	C	10
0600	QTY	Quantity	C	10
0610	ALI	Additional information	C	10
0620	GIN	Goods identity number	C	100
0630	GIR	Related identification numbers	C	100
0640	DLM	Delivery limitations	C	100
0650	DTM	Date/time/period	C	5
0660	NAD	Name and address	C	5

0670	TDT	Details of transport	C	1
0680	HAN	Handling instructions	C	20
0690	FTX	Free text	C	99
0700	MOA	Monetary amount	C	5
0710				
Segment group 16			C	99
0720	RFF	Reference	M	1
0730	NAD	Name and address	C	1
0740	CTA	Contact information	C	1
	DTM	Date/time/period	C	1
0750				
0760				
Segment group 17			C	10
0770	DGS	Dangerous goods	M	1
0780	QTY	Quantity	C	1
0790	FTX	Free text	C	5
0800				
Segment group 18			C	100
0810	LOC	Place/location identification	M	1
0820	NAD	Name and address	C	1
0830	DTM	Date/time/period	C	1
	QTY	Quantity	C	1
0840				
0850				
Segment group 19			C	1000
0860	SGP	Split goods placement	M	1
0870	QTY	Quantity	C	10
0880				
Segment group 20			C	9999
0890	PCI	Package identification	M	1
0900	DTM	Date/time/period	C	5
0910				
0910	MEA	Measurements	C	10
0920	QTY	Quantity	C	1
0930				
Segment group 21			C	10
0940	GIN	Goods identity number	M	1
0950	DLM	Delivery limitations	C	100
0960				
Segment group 22			C	10
0970	HAN	Handling instructions	M	1
0980	FTX	Free text	C	5
0990	GIN	Goods identity number	C	1000
1000				
Segment group 23			C	10
1010	QVR	Quantity variances	M	1
1020	DTM	Date/time/period	C	5
1030				
1030	CNT	Control total	C	5
1040	UNT	Message trailer	M	1

3.3. BRANCHING DIAGRAM

The branching diagram shows the structure of the message. It is a combination of various segments that are organized in a certain hierarchical order.

A segment is a pre-defined set of functionally related values (e.g., segment NAD groups all values that relate to a Party: name - address - etc.)

Each segment within the branching diagram is broken down into one or multiple data elements. Within a segment, only those data elements that contain data must appear.

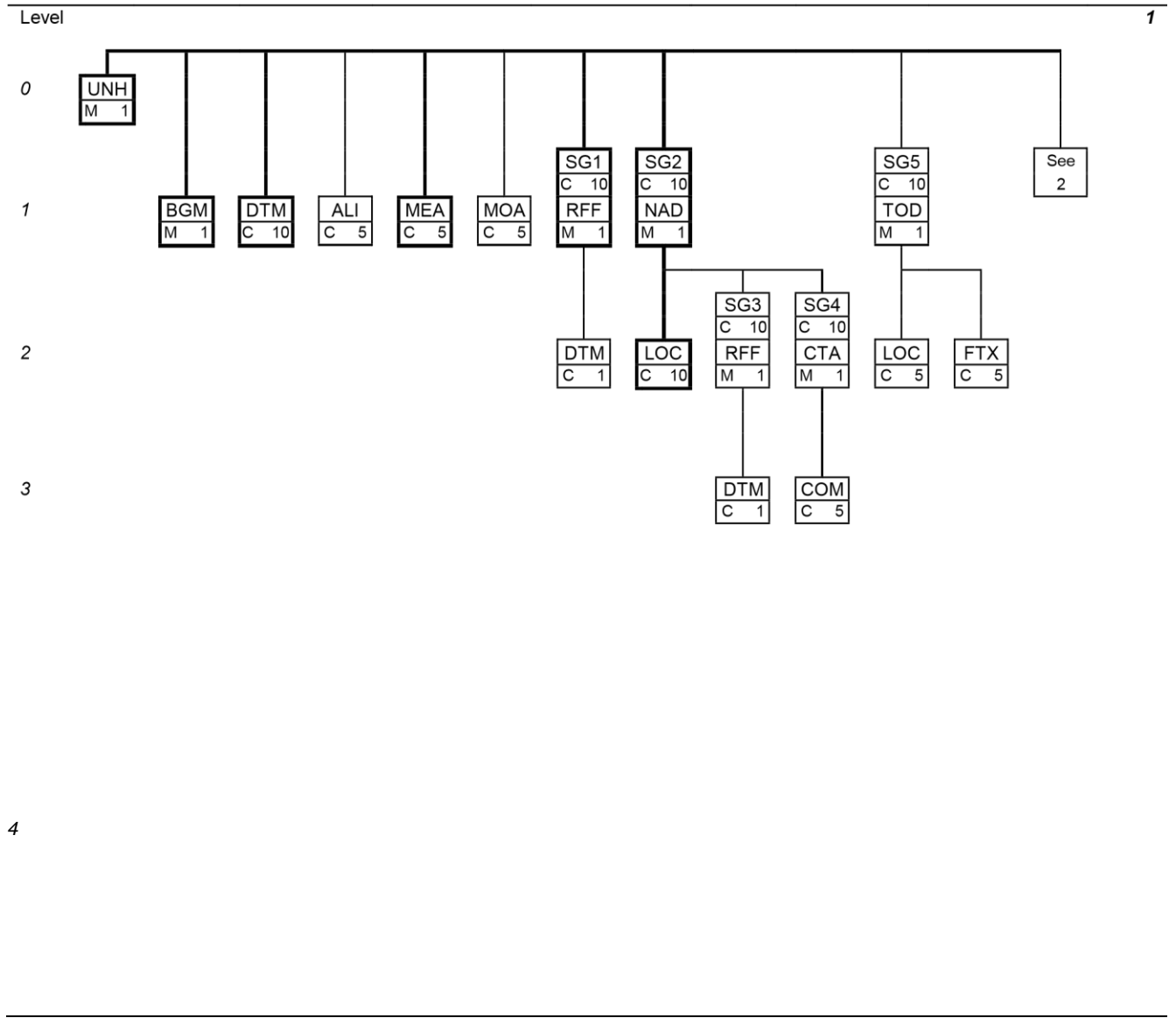

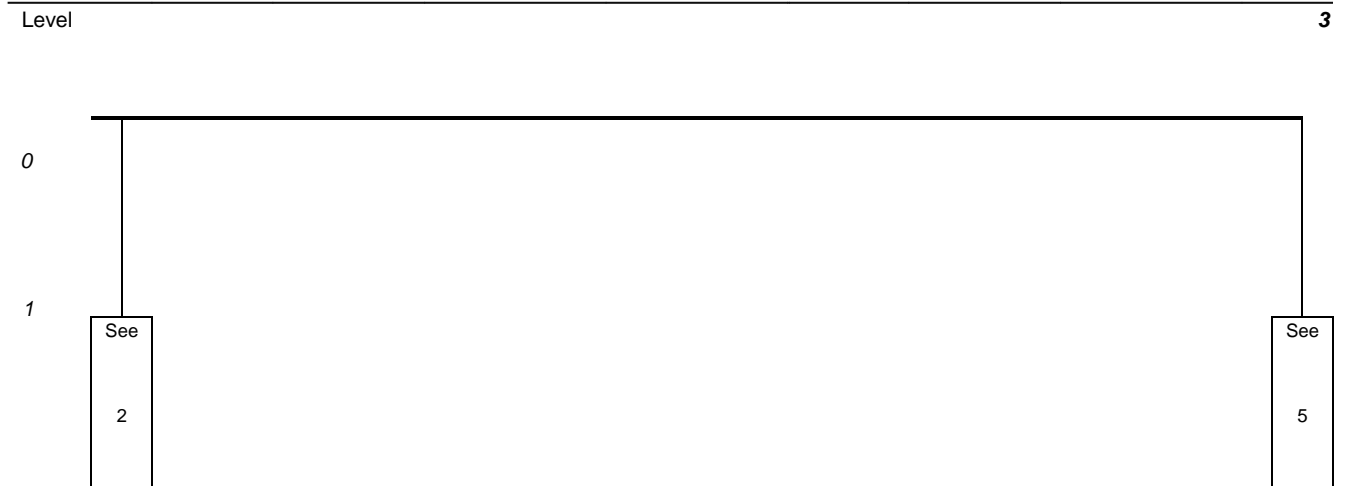
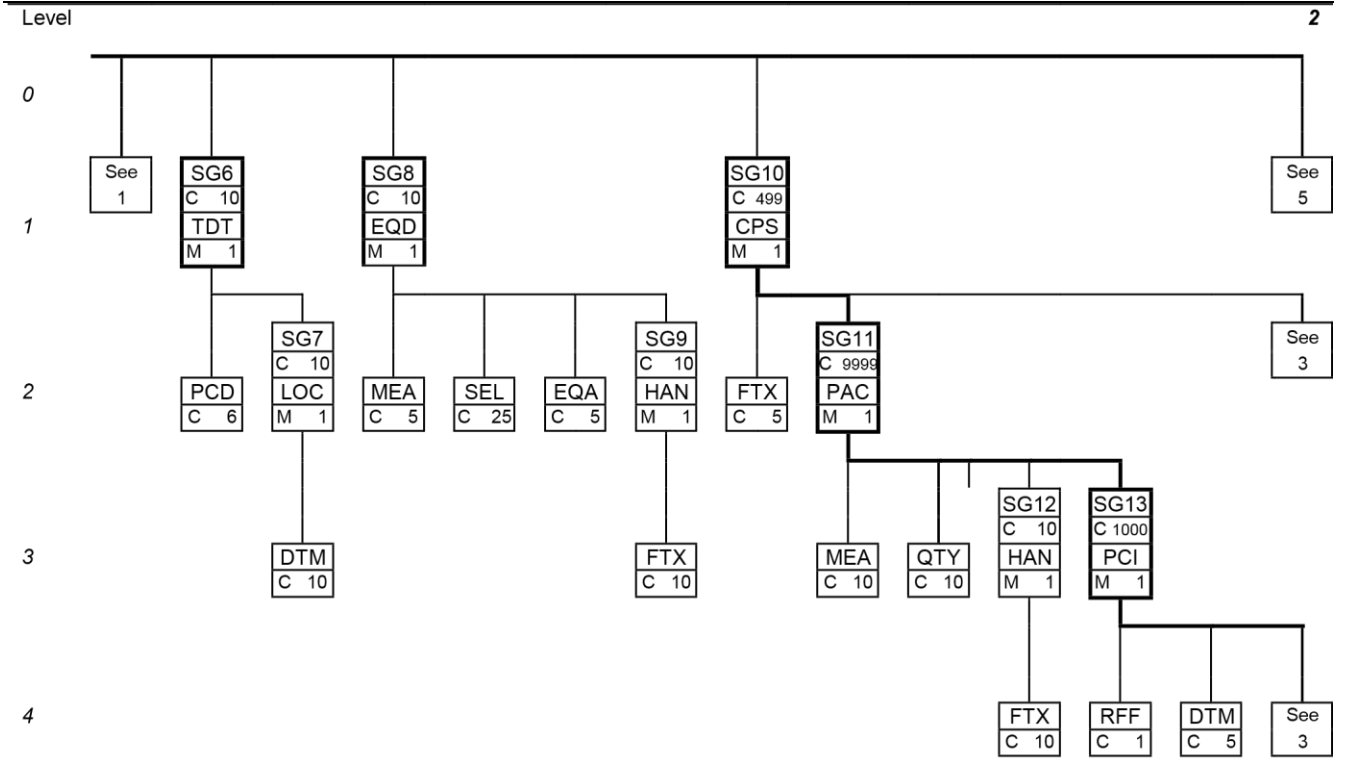

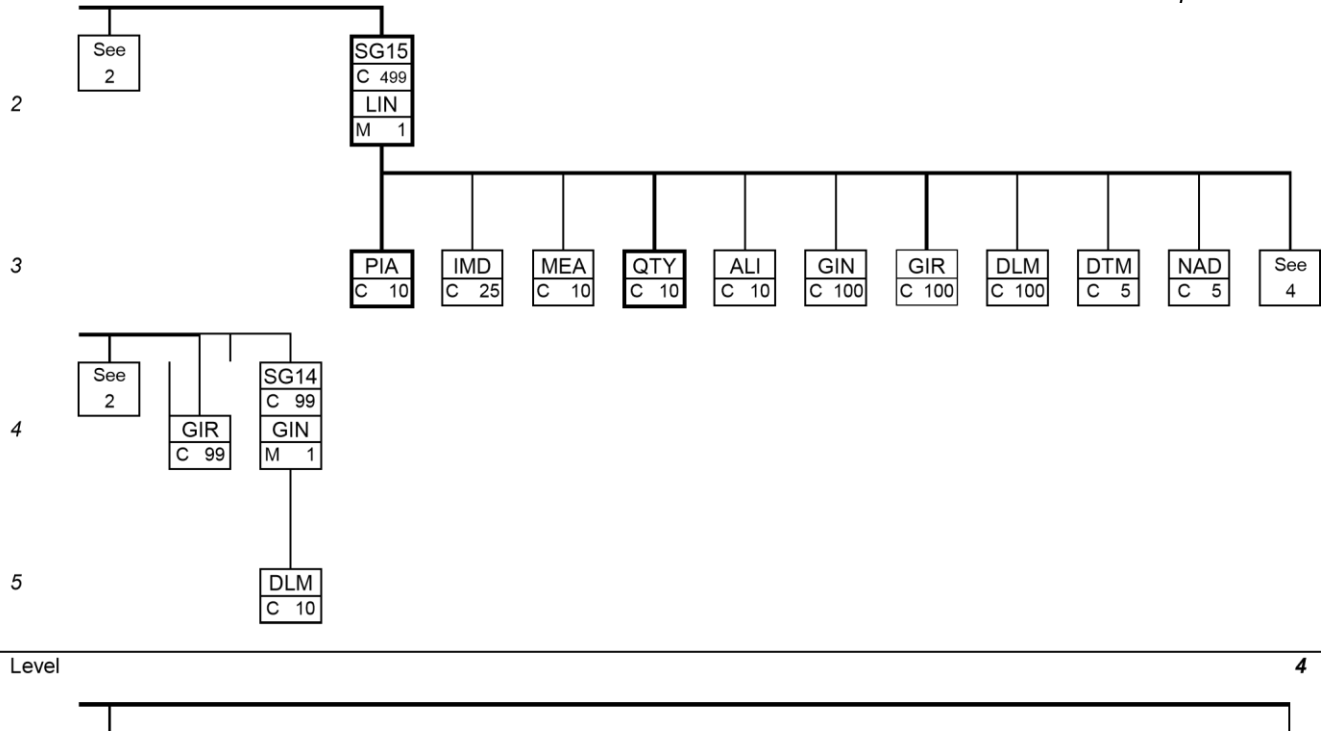

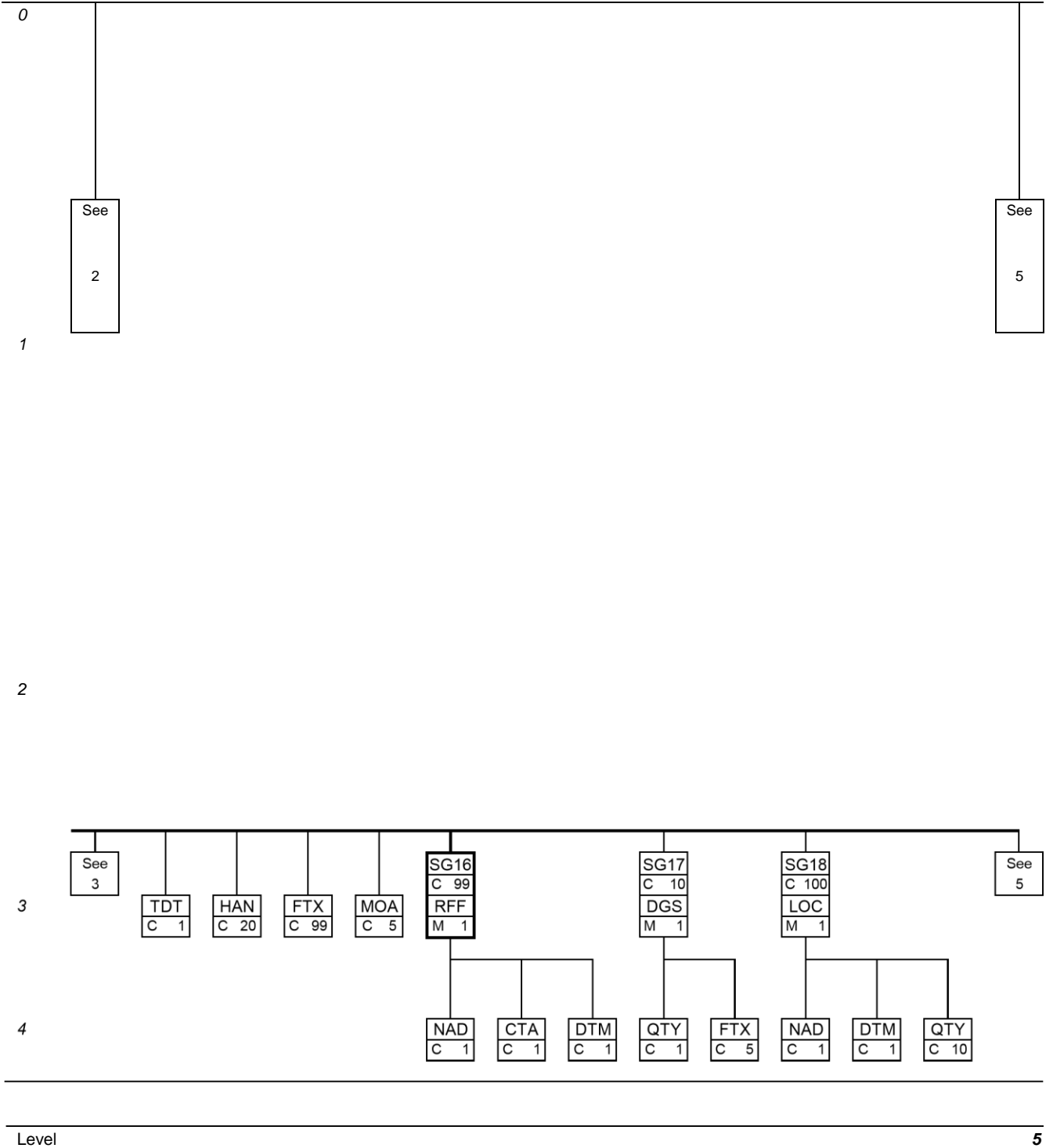

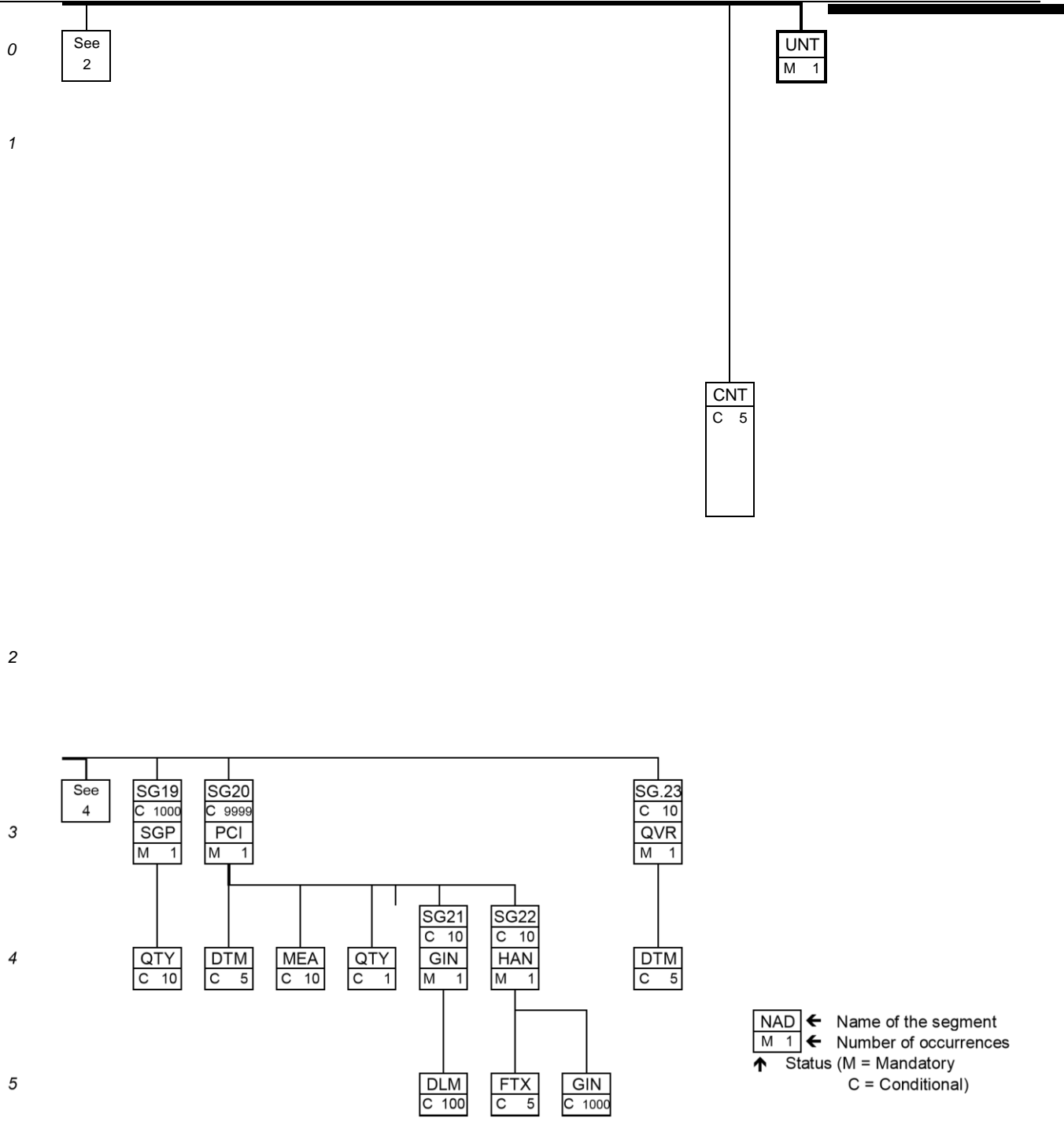

3.4. MESSAGE STANDARD DESCRIPTION

This section provides the description of the UN Standard Message DESADV as defined in the 97.A Directory. Only the segments printed in bold are used in the subset defined by Nexteer and will be further explained in section 3.6.

3.5.1 Header section

Information to be provided in the Header section:

- 0010 UNH, Message header**
A service segment starting and uniquely identifying a message. The message type code for the Despatch advice message is DESADV.
- 0020 BGM, Beginning of message**
A segment for unique identification of the Despatch Advice document, by means of its name and its number.
- 0030 DTM, Date/time/period**
Date/time/period related to the whole message. The DTM segment must be specified at least once to identify the Despatch Advice date.
- 0040 ALI, Additional information
A segment indicating that the message is subject to special conditions due to origin, customs preference or commercial factors.
- 0050 MEA, Measurements**
A segment specifying the weight and volume of the consignment.
- 0060 MOA, Monetary amount
A segment to transmit monetary amounts for the whole despatch required by the consignee to prepare customs clearance procedures.
- 0070 Segment group 1: RFF-DTM**
A group of segments giving references where necessary, dates relating to the whole message, e.g. contract number.
- 0080 RFF, Reference**
A segment for referencing documents relating to the whole despatch advice message, e.g. purchase orders, delivery instructions, import/export license.
- 0090 DTM, Date/time/period
Date/time/period from the referred document.
- 0100 Segment group 2: NAD-LOC-SG3-SG4**
A group of segments identifying names, addresses, locations, and required supporting documents relevant to the whole Despatch Advice.
- 0110 NAD, Name and address**
A segment for identifying names, addresses, and their functions relevant to the whole Despatch Advice. Identification of the parties involved is recommended for the Despatch Advice message, and is to be given in the NAD segment.
It is recommended that where possible, only the coded form of the party ID should be specified, e.g. the buyer and seller are known to each other, thus only the coded ID is required. The consignee or delivery address may vary and would have to be clearly specified, preferably in structured format.
- 0120 LOC, Place/location identification**
A segment indicating more details regarding specific places/locations related to the party specified in the NAD segment, e.g. internal site/building number.
- 0130 Segment group 3: RFF-DTM
A group of segments giving references relevant only to the specified party rather than the whole message.
- 0140 RFF, Reference
A segment for referencing documents relating to the party specified by the NAD segment.
- 0150 DTM, Date/time/period
A segment for specifying Date/time/period of the referred document.
- 0160 Segment group 4: CTA-COM
A group of segments to identify the people, functions, departments and appropriate numbers to whom communication should be directed.
- 0170 CTA, Contact information
A segment to identify the person, function or department to whom communication should be directed.
- 0180 COM, Communication contact
A segment to identify communication types and numbers for the person, function or department identified in the CTA.
- 0190 Segment group 5: TOD-LOC-FTX
A group of segments indicating terms of delivery.
- 0200 TOD, Terms of delivery or transport
A segment indicating the terms of delivery and transfer for the whole despatch advice.

- 0210 LOC, Place/location identification
A segment indicating locations relevant to the TOD segment.
- 0220 FTX, Free text
Additional free text pertinent to terms of delivery. In computer-to-computer exchanges such text will normally require the receiver to process this segment manually.
- 0230 Segment group 6: TDT-PCD-SG7**
A group of segments specifying details of the mode and means of transport and date/time of departure and destination relevant to the whole despatch advice.
- 0240 TDT, Details of transport**
A segment specifying the carriage, and the mode and means of transport of the goods being despatched.
- 0250 PCD, Percentage details
A segment specifying the percentage of utilization of the capacity of the means of transport.
- 0260 Segment group 7: LOC-DTM
A group of segments giving the location and date/time information relative to the transportation.
- 0270 LOC, Place/location identification
A segment indicating locations relevant to the transport specified in the TDT segment.
- 0280 DTM, Date/time/period
A segment giving the date/time/period information of departure and/or arrival of the transported goods for the specified location.
- 0290 Segment group 8: EQD-MEA-SEL-EQA-SG9**
A group of segments providing information relative to the equipment used for the transportation of goods relevant to the whole despatch advice.
- 0300 EQD, Equipment details**
A segment to define fixed information regarding equipment used in conjunction with the whole despatch advice, and if required, to indicate responsibility for supply of the equipment.
- 0310 MEA, Measurements
A segment specifying physical measurements of equipment described in the EQD segment.
- 0320 SEL, Seal number
A segment specifying a seal number connected to a specific equipment named in the EQD.
- 0330 EQA, Attached equipment
A segment identifying equipment either attached to the equipment described in the EQD segment above, or equipment related to that described in the EQD segment, and which is further defined in a subsequent EQD segment.
- 0340 Segment group 9: HAN-FTX
A group of segments providing information on hazardous goods and their handling.
- 0350 HAN, Handling instructions
A segment providing information on handling and notification of hazardous materials in the specified equipment.
- 0360 FTX, Free text
A segment with free text information in coded or clear form to give further clarification, when required, for hazardous material.

3.5.2 Detail section

Information to be provided in the Detail section:

0370 Segment group 10: CPS-FTX-SG11-SG15

A group of segments providing details of all package levels and of the individual despatched items contained in the consignment. This segment group provides the capability to give the hierarchical packing relationships. The group defines a logical top-down order structure. The lowest level package information of the hierarchy is followed by the detail product information.

0380 CPS, Consignment packing sequence

A segment identifying the sequence in which packing of the consignment occurs, e.g. boxes loaded onto a pallet.

0390 FTX, Free text

A segment with free text information in coded or clear form to give further clarification, when required, as to the packing sequence.

In computer-to-computer exchanges such text will normally require the receiver to process this segment manually.

0400 Segment group 11: PAC-MEA-QTY-SG12-SG13

A group of segments identifying packaging, physical dimensions, marks and numbers, quantities, date and time information, handling information and information about packing at this level.

0410 PAC, Package

A segment specifying the number and type of the packages/physical units and the physical type of packaging for the despatched goods.

0420 MEA, Measurements

A segment specifying physical measurements of the packages/physical units described in the PAC segment.

0430 QTY, Quantity

A segment to specify the quantity per package described in the PAC segment.

0440 Segment group 12: HAN-FTX

A group of segments providing information on hazardous goods and handling.

0450 HAN, Handling instructions

A segment providing information on required handling and notification of hazardous materials in the specified package.

0460 FTX, Free text

A segment with free text information in coded or clear form to give further clarification, when required, for hazardous materials.

0470 Segment group 13: PCI-RFF-DTM-GIR-SG14

A group of segments specifying markings, labels, and packing numbers.

0480 PCI, Package identification

A segment specifying markings and/or labels used on individual physical units (packages) described in the PAC segment.

0490 RFF, Reference

A segment for referencing the package identification e.g. master label number.

0500 DTM, Date/time/period

A segment for specifying date/time/period related to the document referenced.

0510 GIR, Related identification numbers

A segment providing set of package identification related numbers, e.g. a package label number and a KANBAN card number assigned to the same package.

0520 Segment group 14: GIN-DLM

A group of segments giving package identification numbers and, where relevant, delivery limitation information.

0530 GIN, Goods identity number

A segment providing the identity numbers of packages being despatched.

0540 DLM, Delivery limitations

A segment to identify any limitation on delivery of goods, e.g. hold until final approval by supplier.

- 0550 Segment group 15: LIN-PIA-IMD-MEA-QTY-ALI-GIN-GIR-DLM-DTM-NAD-TDT-HAN-FTX-MOA-SG16-SG17-SG18-SG19-SG20-SG23**
 A group of segments providing details of the individual despatched items.
- 0560 LIN, Line item**
 A segment identifying the product being despatched. All other segments in the detail section following the LIN segment refer to that line item.
- 0570 PIA, Additional product id**
 A segment providing additional product identification.
- 0580 IMD, Item description
 A segment for describing the product being despatched. This segment should be used for products that cannot be identified by a product code or article number.
- 0590 MEA, Measurements
 A segment specifying physical measurements of the despatched item in original or unpacked form.
- 0600 QTY, Quantity**
 A segment to give quantity information concerning the product.
- 0610 ALI, Additional information
 A segment indicating that the line item is subject to special conditions due to origin, customs preference, or commercial factors.
- 0620 GIN, Goods identity number
 A segment providing identity numbers of the goods being despatched, e.g. serial numbers for assembled equipment.
- 0630 GIR, Related identification numbers
 A segment providing sets of related identification numbers for a line item, e.g. engine number, chassis number and transmission number for a vehicle.
- 0640 DLM, Delivery limitations
 A segment to identify any limitation on delivery of goods e.g. hold until final approval by supplier.
- 0650 DTM, Date/time/period
 A segment providing date, time information related to the line item, e.g. production date.
- 0660 NAD, Name and address
 A segment for identifying names and addresses and their functions relevant to the item, e.g. manufacturer.
- 0670 TDT, Details of transport
 A segment specifying the carriage, and the mode and means of transport of the goods being despatched, e.g. shipment/consignment number, shipping method, carrier.
- 0680 HAN, Handling instructions
 A segment providing information on the handling and notification of hazardous materials.
- 0690 FTX, Free text
 A segment with free text information in coded or clear form to give further clarification, when required, to the line item. In computer-to-computer exchanges such text will normally require the receiver to process this segment manually.
- 0700 MOA, Monetary amount
 A segment giving monetary amounts required by the consignee to undertake customs clearance procedures.
- 0710 Segment group 16: RFF-NAD-CTA-DTM**
 A group of segments to give reference numbers and dates.
- 0720 RFF, Reference**
 A segment identifying documents related to the line item.
- 0730 NAD, Name and address
 A segment for identifying names and addresses and their functions relevant to the originator of the document in the RFF segment.
- 0740 CTA, Contact information
 A segment to identify the office, branch or department to whom communication relevant to the document should be directed.
- 0750 DTM, Date/time/period
 A segment for date/time/period relative to the referred document.
- 0760 Segment group 17: DGS-QTY-FTX
 A group of segments giving information about dangerous goods.

- 0770 DGS, Dangerous goods
A segment to indicate the class of dangerous goods.
- 0780 QTY, Quantity
A segment to specify quantity of the given dangerous goods.
- 0790 FTX, Free text
A segment to describe dangerous goods.
- 0800 Segment group 18: LOC-NAD-DTM-QTY
A group of segments giving location information and where relevant, additional addresses, date and time, and quantities.
- 0810 LOC, Place/location identification
A segment identifying a specific location to which products will be delivered.
- 0820 NAD, Name and address
A segment for identifying names and addresses and their functions relevant to the delivery point. It is recommended that where possible only the coded form of the party ID should be specified, e.g. the buyer and seller are known to each other, thus only the coded ID is required. The consignee or delivery address may vary and would have to be clearly specified, preferably in structured format.
- 0830 DTM, Date/time/period
A segment providing date/time information relevant for delivery to the specific location.
- 0840 QTY, Quantity
A segment to specify quantity for the given location.
- 0850 Segment group 19: SGP-QTY
A group of segments indicating the split placement of packages or unpacked goods into equipment.
- 0860 SGP, Split goods placement
A segment to specify the placement of goods in relation to one equipment. If goods are unpacked, their quantity would be given in the following QTY segment.
- 0870 QTY, Quantity
A segment to specify the quantity of unpacked goods being placed in a specific equipment.
- 0880 Segment group 20: PCI-DTM-MEA-QTY-SG21-SG22
A group of segments identifying one specific package or a number of packages, their marks and numbers, measurements, quantities, date and time information and handling instructions.
- 0890 PCI, Package identification
A segment specifying marking and labels used on individual packages or a range of packages.
- 0900 DTM, Date/time/period
A segment giving the date/time details related to the goods within the packages e.g. expiration date.
- 0910 MEA, Measurements
A segment specifying physical measurements of packages.
- 0920 QTY, Quantity
A segment to specify quantity per package.
- 0930 Segment group 21: GIN-DLM
A group of segments giving package identification numbers and, where relevant, delivery limitation information.
- 0940 GIN, Goods identity number
A segment providing identification numbers being applied to the packages despatched.
- 0950 DLM, Delivery limitations
A segment to identify any limitation on delivery of goods e.g. hold until final approval by supplier.
- 0960 Segment group 22: HAN-FTX-GIN
A group of segment providing information on hazardous materials and handling.
- 0970 HAN, Handling instructions
A segment providing information on handling and notification of hazardous materials.
- 0980 FTX, Free text
A segment with free text information in coded or clear form to give further clarification, when required, for hazardous materials.
- 0990 GIN, Goods identity number
A segment providing identification numbers being applied to the packages containing hazardous goods.

- 1000 Segment group 23: QVR-DTM
A group of segments identifying quantity variances, the reason for the variance, and, when relevant, date and time information.
- 1010 QVR, Quantity variances
A segment identifying a quantity variance and the reason for the variance.
- 1020 DTM, Date/time/period
A segment to give date and time information relative to the quantity variances, e.g. proposed delivery date on the back order.

3.5.3 Summary section

Information to be provided in the Summary section:

- 1030 CNT, Control total
A segment by which control totals may be provided by sender for checking by the receiver.
- 1040 UNT, Message trailer**
A service segment ending a message, giving the total number of segments in the message and the control reference number of the message.

3.5. MESSAGE STRUCTURE

The message structure illustrates how the segments can be repeated in the Despatch Advice message to accommodate the requirements identified by Nexteer.

0010.UNH
0020.BGM
0030-1.DTM
0030-2.DTM
0050-1.MEA
0050-2.MEA
0050-1.MEA
0080.RFF
0110-1.NAD
0110-2.NAD

Start of Despatch Advice Message
Message identification
Message generation date/time Despatch date/time
Shipment gross weight Shipment net weight Total number of lading units
Waybill number
Planning schedule/material release issuer (buyer) Ship to identification Delivery dock Supplier identification
Transport details
Equipment details

1.6. SERVICE SEGMENTS DESCRIPTION

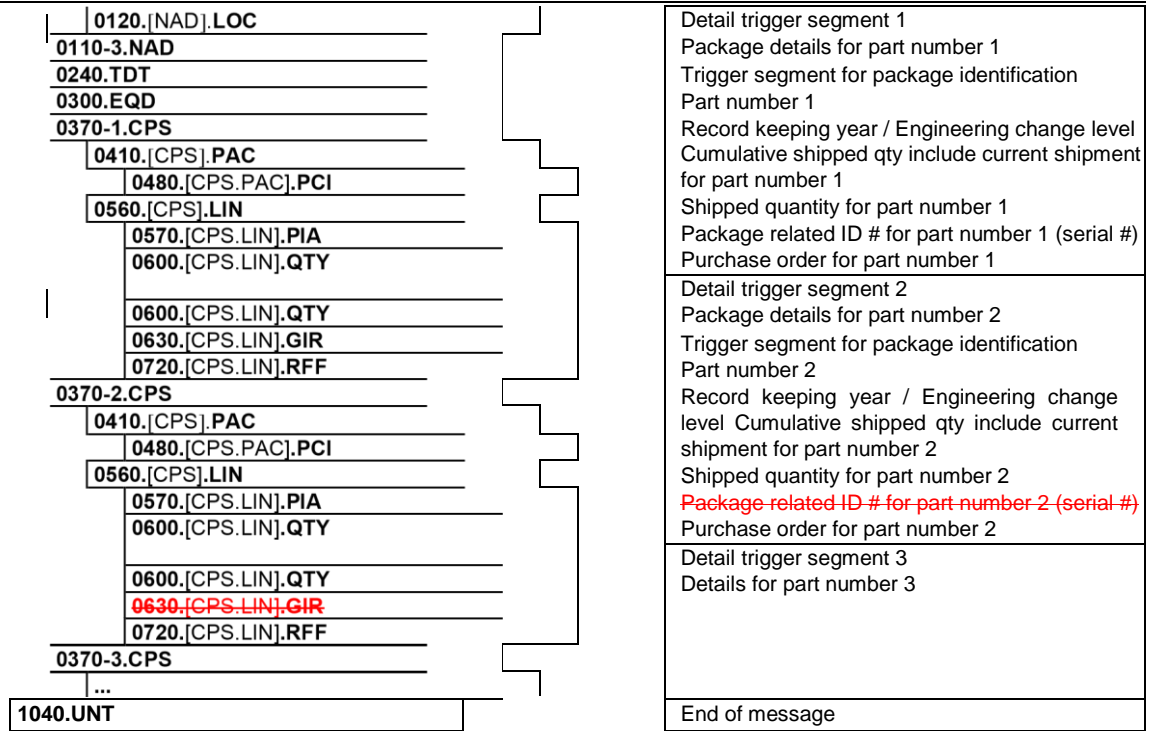

Following service segments are as defined by UN/EDIFACT and presented under ISO 9735.

The UNB, UNH, UNT and UNZ segments are the envelope of any message, enclosing all the data that is being transmitted.

The UNB (Interchange header) and UNZ (Interchange trailer) segments mark respectively the beginning and the end of an interchange thereby providing a unique interchange control reference.

Within the interchange the UNH (message header) and UNT (Message trailer) segments uniquely begin and end the various messages contained in an interchange.

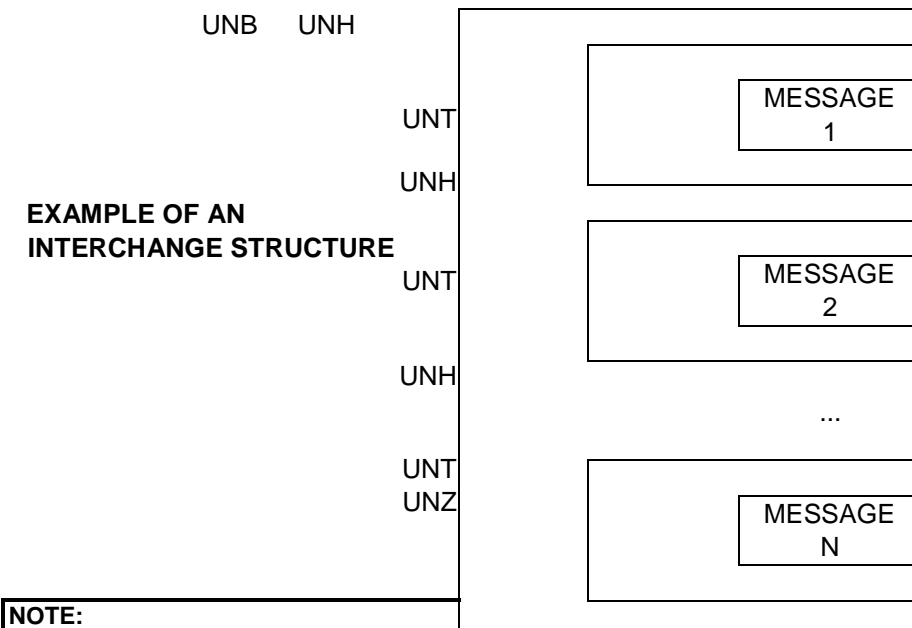

All data elements marked "M" for Mandatory in the "ST" field of the Nexteer implementation must be included in the message. Missing or incorrect entries will result in the rejection of the message.

0000 UNB - INTERCHANGE HEADER

Segment Group: none Level: 0
 EDIFACT status: mandatory Nexteer status: mandatory
 Maximum use: 1 per interchange Nexteer occurrences: 1 per interchange
 Function: Service segment providing the unique identification of an interchange. It allows the identification of the sender and the receiver of the interchange, gives date and time of preparation as well as the interchange control reference and the application reference. Nexteer interchange: see remarks.

Example: **UNB+UNOA:2+QQQ:ZZ+NEXTEERNA:ZZ+030325:0200+233++DESADV'**
 A B C D E F G H I

EDIFACT STANDARD DEFINITION					Nexteer IMPLEMENTATION		
A	S001	SYNTAX IDENTIFIER	M		M		
B	0001	Syntax identifier	M	a4	:	M	a4
	0002	Syntax version number	M	n1	+	M	n1
							"UNOA". Indication of the syntax version used for this message.
C	S002	INTERCHANGE SENDER	M		M		
	0004	Sender identification	M	an..35	:	M	an..35
							Communication Code/Mailbox number of the party originating the message.
D	0007	Identification code qualifier Address	C	an..4	:	M	an..02
	0008	for Reverse Routing	C	an..14	+		
							"ZZ" mutually defined
E	S003	INTERCHANGE RECIPIENT	M		M		
	0010	Recipient identification	M	an..35	:	M	an..35
							Communication Code/Mailbox number of the party receiving the message.
F	0007	Identification code qualifier	C	an..4	:	M	an..02
	0014	Routing address	C	an..14	+		
							"ZZ" mutually defined
G	S004	DATE / TIME OF PREPARATION	M		M		
H	0017	Date of preparation	M	n6	:	M	n6
	0019	Time of preparation	M	n4	+	M	n4
							YYMMDD format HHMM format
I	0020	INTERCHANGE CONTROL REFERENCE	M	an..14	+	M	an..14
							Reference number assigned by the sender of the message. This number must uniquely identify each interface and must be UNIQUE within an inventory year.
	S005	RECIPIENTS REFERENCE PASSWORD	C				
	0022	Recipient's reference / password	M	an..14	:		
	0025	Recipient's reference / password qualifier	C	an2	+		
	0026	APPLICATION REFERENCE	C	an..14	+	M	n6
	0029	PROCESSING PRIORITY CODE	C	a1	+		
	0031	ACKNOWLEDGEMENT REQUEST	C	n1	+		
	0032	COMMUNICATIONS AGREEMENT ID	C	an..35	+		
	0035	TEST INDICATOR	C	n1	'	C	n1
							Used for Test only

Note: Century is not used in tag 0017, 0019

0010 UNH - MESSAGE HEADER

Segment group: none Level: 0
 EDIFACT status: mandatory. Nexteer status: mandatory.
 Maximum use: 1 per message. Nexteer occurrences: 1 per message.
 Function: service segment starting and uniquely identifying a message. The message type code for the Despatch Advice message is DESADV. Nexteer interchange: see remarks.

Example: **UNH+4+DESADV:D:97A:UN'**
 A B C D E

EDIFACT STANDARD DEFINITION						Nexteer IMPLEMENTATION		
REF	TAG	NAME	ST	FT	SP	ST	FT	REMARKS
A	0062	MESSAGE REFERENCE NUMBER	M	an..14	+	M	an..14	Message Control number assigned by the sender to the message.
	S009	MESSAGE IDENTIFIER	M			M		
B	0065	Message type	M	an..6	:	M	an..6	"DESADV"
C	0052	Message version number	M	an..3	:	M	an..3	"D"
D	0054	Message release number	M	an..3	:	M	an..3	"97A"
E	0051	Controlling agency	M	an..2	:	M	an..2	"UN"
	0057	Association assigned code	C	an..6	+			
	0068	COMMON ACCESS REFERENCE	C	an..35	+			
	S010	STATUS OF TRANSFER	C					
	0070	Sequence of transfer	M	n..2	:			
	0073	First and last transfer	C	a1	'			

COMMENTS

The Message Reference number is structured as follows:

First message: 1 Second message: 2 max.: 9999

1040 UNT - MESSAGE TRAILER

Segment group: none Level: 0
 EDIFACT status: mandatory. Nexteer status: mandatory.
 Maximum use: 1 per message. Nexteer occurrences: 1 per message.
 Function: service segment ending a message, giving the total number of segments in the message and the control reference number of the message. Nexteer interchange:

Example: **UNT+31+4'**
 A B

EDIFACT STANDARD DEFINITION						Nexteer IMPLEMENTATION		
REF	TAG	NAME	ST	FT	SP	ST	FT	REMARKS
A	0074	NUMBER OF SEGMENTS IN THE MESSAGE	M	n..6		M	n..6	Control count of the number of segments in the message, including UNH and UNT.
B	0062	MESSAGE REFERENCE NUMBER	M	an..14		M	an..14	Number must be identical to UNH - tag 0062

1050 UNZ - INTERCHANGE TRAILER

Segment Group: none Level: 0
 EDIFACT status: mandatory Nexteer status: mandatory
 Maximum use: 1 Nexteer occurrences: 1 per interchange
 Function: service segment ending an interchange and giving the number of messages contained in the interchange as well as the Interchange Control Reference number. Nexteer interchange:

Example: **UNZ+1+233'**
 A B

EDIFACT STANDARD DEFINITION						Nexteer IMPLEMENTATION		
REF	TAG	NAME	ST	FT	SP	ST	FT	REMARKS
A	0036	INTERCHANGE CONTROL COUNT	M	n..6	+	M	n..6	Number of messages in an interchange.
B	0020	INTERCHANGE CONTROL REFERENCE	M	an..14	'	M	an..14	Value must be the same as 0020 - Interchange Control Reference in UNB.

3.7. DATA SEGMENTS DESCRIPTION

This part includes only the segments defined in the standard and used in the subset exchanged between the Trading Partners and Nexteer. The segments are described in the same sequence as they appear in the message.

The EDIFACT DESADV segments that are not used in the subset used by Nexteer are included in alphabetical sequence under item 3.9.

NOTE: All data elements marked "M" for Mandatory in the "ST" field of the Nexteer implementation must be included in the message. Missing or incorrect entries will result in the rejection of the message.

0020 BGM - BEGINNING OF MESSAGE

Segment group: none Level: 1
 EDIFACT status: mandatory Nexteer status: mandatory
 Maximum use: 1 per message Nexteer occurrences: 1 per message
 Function: segment for unique identification of the Despatch Advice document, by means of its name and its number.

Note: Use only alpha and /or numeric characters in the BGM segment. Special characters or symbols may cause failure.

Example: **BGM++123456+9'** **Limit to 10 characters**
 A B

EDIFACT STANDARD DEFINITION					Nexteer IMPLEMENTATION		
	C002	DOCUMENT/MESSAGE NAME	C				
	1001	Document/message name, coded	C	an..3	:		
	1131	Code list qualifier	C	an..3	:		
	3055	Code list responsible agency, coded	C	an..3	:		
	1000	Document/message name	C	an..35	+		
A	C106	DOCUMENT/MESSAGE IDENTIFICATION	C			M	
	1004	Document/message number	C	an..35	:	M	an..10 A unique control number, commonly called a Shipment Identification Number (SID), assigned by the original shipper to identify a specific shipment. This unique control number cannot be repeated within a one-year period. This number must be the same as the packing slip/master bill of lading The SID number will be used by NEXTEER as the reference number on the payment remittance to the supplier. NOTE: ASN # must equal the packing slip number in the RFF:MB segment
B	1056	Version	C	an..9	:		
	1060	Revision number	C	an..6	+		
	1225	MESSAGE FUNCTION, CODED	C	an..3	+	M	an..3 Function of the message. For code values see below. Note: "9" is currently the only code which Nexteer will automatically process.
	4343	RESPONSE TYPE, CODED	C	an..3	'		

CODE VALUES

1225 - Message function, coded

- 1 Cancellation
Message canceling a previous transmission for a given transaction. The issuer's subsequent transmission of an SID, canceling all data previously transmitted under that SID (1004).
- 2 Addition
Message containing items (e.g. line items, goods items, Customs items, equipment items) to be added to a previously sent message. The issuer's subsequent transmission of an SID, adding part specific data not previously transmitted under that SID (1004).
- 4 Change
Message containing items (e.g. line items, goods items, Customs items, equipment items) to be changed in a previously sent message. The issuer's subsequent transmission of an SID, changing data previously transmitted under that SID (1004).
- 9 Original
Initial transmission related to a given transaction. The issuer's first transmission of a message for a particular SID (1004). **Note: Use Message function, coded (1225) value as 9.**

0030 DTM - DATE/TIME/PERIOD

Segment group: none Level: 1
 EDIFACT status: mandatory Nexteer status: mandatory (see comments)
 Maximum use: 10 per message at level 1 Nexteer occurrences: max. 3 per message
 Function: segment specifying the date/time/period related to the whole message. The DTM segment must be specified at least once to identify the Despatch Advice date.
 Nexteer interchange: there may be max. 3 occurrences of DTM in position 0030: to specify the message issue date, to specify the despatch date and/or time and to specify the estimated arrival date/time. **The 2 first occurrences are mandatory in the messages exchanged with Nexteer.**

Example: **DTM+137: 200303250200:203'** Document generation, *mandatory*
DTM+11: 200303250200:203' Despatch date/time, *mandatory*
 A B C

EDIFACT STANDARD DEFINITION						Nexteer IMPLEMENTATION		
REF	TAG	NAME	ST	FT	SP	ST	FT	REMARKS
Document generation date. MANDATORY - must be transmitted.								
	C507	DATE/TIME/PERIOD	M			M		
A	2005	Date/time/period qualifier	M	an..3	:	M	an..3	"137" = Document/message date/time.
B	2380	Date/time/period	C	an..35	:	M	an..35	Date/time when the document is issued.
C	2379	Date/time/period format qualifier	C	an..3	"	M	an..3	"203" = CCYYMMDDHHMM.
Despatch date/time. MANDATORY - must be transmitted.								
	C507	DATE/TIME/PERIOD	M			M		
A	2005	Date/time/period qualifier	M	an..3	:	M	an..3	"11" = Despatch date and or time.
B	2380	Date/time/period	C	an..35	:	M	an..35	Date/time on which the goods are actually despatched or shipped.
C	2379	Date/time/period format qualifier	C	an..3	'	M	an..3	"203" = CCYYMMDDHHMM.

0050 MEA - MEASUREMENTS

Segment group: none Level: 1
 EDIFACT status: conditional Nexteer status: mandatory
 Maximum use: 5 per message at level 1 Nexteer occurrences: max. 3 per message
 Function: segment specifying the weight and volume of the consignment.
 Nexteer interchange: there need to be 3 occurrences of MEA in position 0050 specifying the gross weight and the net weight of the shipment and the total number of lading units.
 Example: **MEA+AAX+G+LBR:200'** Gross Weight, *mandatory*
MEA+AAX+N+LBR:200' Net weight, *mandatory*
MEA+AAX+SQ+PC:44' Ship quantity, *mandatory*
 A B C D

EDIFACT STANDARD DEFINITION						Nexteer IMPLEMENTATION		
REF	TAG	NAME	ST	FT	SP	ST	FT	REMARKS

Gross weight *Note: Measurement unit qualifier, use KGM or LBR when used with G (6313 – Gross Weight)*

A	6311	MEASUREMENT PURPOSE QUALIFIER	M	an..3	+	M	an..3	"AAX" = Consignment measurements.
	C502	MEASUREMENT DETAILS	C			C		
B	6313	Property measured, coded	C	an..3	:	M	an..3	"G" = Gross Weight.
	6321	Measurement significance, coded	C	an..3	:			
	6155	Measurement attribute identification	C	an..17	:			
	6154	Measurement attribute	C	an..70	+			
	C174	VALUE/RANGE	C					
C	6411	Measure unit qualifier	M	an..3	:	M	an..3	For code see UN/ECE Recommendation Nr 20
D	6314	Measurement value Range	C	an..18	:	M	an..18	Actual weight. No decimal digits!
	6162	minimum	C	n..18	:			
	6152	Range maximum	C	n..18	:			
	6432	Significant digits	C	n..2	+			
	7383	SURFACE/LAYER INDICATOR, CODED	C	an..3	'			

Net weight *Note: Measurement unit qualifier, use KGM or LBR when used with N (6313 – Net Weight)*

A	6311	MEASUREMENT PURPOSE QUALIFIER	M	an..3	+	M	an..3	"AAX" = Consignment measurements.
	C502	MEASUREMENT DETAILS	C			C		
B	6313	Property measured, coded	C	an..3	:	M	an..3	"N" = Net Weight.
	6321	Measurement significance, coded	C	an..3	:			
	6155	Measurement attribute identification	C	an..17	:			
	6154	Measurement attribute	C	an..70	+			
	C174	VALUE/RANGE	C					
C	6411	Measure unit qualifier	M	an..3	:	M	an..3	For code see UN/ECE Recommendation Nr 20
D	6314	Measurement value	C	an..18	:	M	an..18	Actual weight . No decimal digits!
REST OF SEGMENT NOT USED.								

Shipped Quantity *Note: Measurement unit qualifier, use PC when used with SQ (6313 – Property measured coded)*

A	6311	MEASUREMENT PURPOSE QUALIFIER	M	an..3	+	M	an..3	"AAX" = Consignment measurements.
	C502	MEASUREMENT DETAILS	C			C		
B	6313	Property measured, coded	C	an..3	:	M	an..3	"SQ" = Total number of Lading units.
	6321	Measurement significance, coded	C	an..3	:			
	6155	Measurement attribute identification	C	an..17	:			
	6154	Measurement attribute	C	an..70	+			
	C174	VALUE/RANGE	C					
C	6411	Measure unit qualifier	M	an..3	:	M	an..3	For code see UN/ECE Recommendation Nr 20
D	6314	Measurement value	C	an..18	:	M	an..18	Quantity
REST OF SEGMENT NOT USED.								

Segment group 1: RFF-DTM

Segment group: 1 Level: 1
 EDIFACT status: conditional Nexteer status: mandatory
 Maximum use: 10 per message at level 1 Nexteer occurrences: max. 2 per message
 Function: group of segments giving references where necessary, their dates relating to the whole message, e.g. contract number.
 Nexteer interchange: only RFF is required in segment group 1.

0080 RFF - REFERENCE

Segment group: 1 [RFF] Level: 1
 EDIFACT status: mandatory if segment group 1 is used Nexteer status: mandatory
 Maximum use: 1 per segment group 1 (max. 10) Nexteer occurrences: 1 per segment group 1
 Function: segment for referencing documents relating to the whole despatch advice message, e.g. purchase orders, delivery instructions, import/export license.

Example: **RFF+MB:123456'** Master Bill of Lading = Shipper/Packing Slip Number
RFF+CN:123456789A'' Carrier Reference Number = Pro Number
 A B

EDIFACT STANDARD DEFINITION				Nexteer IMPLEMENTATION			
Master bill of lading number				Mandatory: Must be transmitted			
	C506	REFERENCE	M				
A	1153	Reference qualifier	M	an..3	:	M	an..3
B	1154	Reference number	C	an..35	:	M	an..35
	1156	Line number	C	an..6	:		
	4000	Reference version number	C	an..35	'		
							"MB" = Master bill of lading number. Shipper/Packing Slip Number NOTE: Must be the same as the ASN # in the BGM segment.

EDIFACT STANDARD DEFINITION				Nexteer IMPLEMENTATION			
Pro Number				Mandatory: Must be transmitted			
	C506	REFERENCE	M				
A	1153	Reference qualifier	M	an..3	:	M	an..3
B	1154	Reference number	C	an..35	:	M	an..35
	1156	Line number	C	an..6	:		
	4000	Reference version number	C	an..35	'		
							"CN" = Carrier Reference Number Pro Number

NOTE: For the RFF+CN segment the PRO number can be one or the following:

- Fed Ex tracking #
- LTL Carrier Pro or Tracking #
- Dedicated or Milk Run Truck Trailer #
- Other Carriers - Pro or Tracking #

Segment group 2: NAD-LOC-SG3-SG4

Segment group: 2 Level: 1
 EDIFACT status: conditional Nexteer status: mandatory
 Maximum use: 10 per message at level 1 Nexteer occurrences: maximum 5 per message
 Function: group of segments identifying names, addresses, locations, and required supporting documents relevant to the whole Despatch Advice. Nexteer interchange: see segment description.

0110 NAD - NAME AND ADDRESS

Segment group: 02 [NAD] Level: 1
 EDIFACT status: mandatory if segment group 02 is used Nexteer status: mandatory
 Maximum use: 1 per segment group 02 (max. 10) Nexteer occurrences: 1 per segment group 2
 Function: segment for identifying names, addresses, and their functions relevant to the whole Despatch Advice.
 Nexteer interchange: the message may contain max. 5 NAD segments as detailed below. Nexteer always requires the transmission of the first 3 occurrences detailed below. If the ship from location is different from the supplier location then the 4th occurrence is also mandatory. The 5th occurrence is only to be transmitted if this information was also included in the DELFOR and/or DELJIT previously transmitted by Nexteer.

Example: **NAD+MI+623700994::16'** Material issuer DUNS#
NAD+ST+H301::92' Ship To
NAD+SU+999123456::16' Supplier DUNS #

A B C D

EDIFACT STANDARD DEFINITION						Nexteer IMPLEMENTATION		
REF	TAG	NAME	ST	FT	SP	ST	FT	REMARKS
Planning schedule/material release issuer.						MANDATORY - must be transmitted		
A	3035	PARTY QUALIFIER	M	an..3	+	M	an..3	"MI" = Planning schedule/material release issuer.
	C082	<i>PARTY IDENTIFICATION DETAILS</i>	C			M		
B	3039	Party id. Identification	M	an..35	:	M	an..35	Code identifying the material release issuer. For code value see below.
	1131	Code list qualifier	C	an..3	:			
C	3055	Code list responsible agency, coded	C	an..3	+	M	an..3	For code value see below.
	C058	<i>NAME AND ADDRESS</i>	C					
	3124	Name and address line	M	an..35	:			
	3124	Name and address line	C	an..35	:			
	3124	Name and address line	C	an..35	:			
	3124	Name and address line	C	an..35	:			
	3124	Name and address line	C	an..35	+			
	C080	<i>PARTY NAME</i>	C					
	3036	Party name	M	an..35	:			
	3036	Party name	C	an..35	:			
	3036	Party name	C	an..35	:			
	3036	Party name	C	an..35	:			

	3036	Party name	C	an..35	:			
	3045	Party name format, coded	C	an..3	+			
	C059	<i>STREET</i>	C					
	3042	Street and number/P.O. box	M	an..35	:			
	3042	Street and number/P.O.. box	C	an..35	:			
	3042	Street and number/P.O.. box	C	an..35	:			
	3042	Street and number/P.O.. box	C	an..35	+			
	3164	CITY NAME	C	an..35	+			
	3229	COUNTRY SUB-ENTITY IDENTIFICATION	C	an..9	+			
	3251	POSTCODE IDENTIFICATION	C	an..9	+			
	3207	COUNTRY, CODED	C	an..3	'			

0110 NAD - CONTINUED

Ship to MANDATORY - must be transmitted.

EDIFACT STANDARD DEFINITION						Nexteer IMPLEMENTATION		
REF	TAG	NAME	ST	FT	SP	ST	FT	REMARKS
A	3035	PARTY QUALIFIER	M	an..3	+	M	an..3	"ST" = Ship to.
	C082	<i>PARTY IDENTIFICATION DETAILS</i>	C			M		
B	3039	Party id. Identification	M	an..35	:	M	an..35	Code identifying the plant where the material must be delivered. For code value see below.
	1131	Code list qualifier	C	an..3	:			
C	3055	Code list responsible agency, coded	C	an..3	+	M	an..3	For code value see below.
	C058	<i>NAME AND ADDRESS</i>	C		+			
	C080	<i>PARTY NAME</i>	C		+			
	C059	<i>STREET</i>	C		+			
	3164	CITY NAME	C	an..35	+			
	3229	COUNTRY SUB-ENTITY IDENTIFICATION	C	an..9	+			
	3251	POSTCODE IDENTIFICATION	C	an..9	+			
	3207	COUNTRY, CODED	C	an..3	'			
REST OF SEGMENT NOT USED.								

Supplier MANDATORY - must be transmitted.

A	3035	PARTY QUALIFIER	M	an..3	+	M	an..3	"SU" = Supplier.
	C082	<i>PARTY IDENTIFICATION DETAILS</i>	C			M		
B	3039	Party id. Identification	M	an..35	:	M	an..35	Code identifying the supplier.
	1131	Code list qualifier	C	an..3	:			
C	3055	Code list responsible agency, coded	C	an..3	+	M	an..3	For code value see below.
	C058	<i>NAME AND ADDRESS</i>	C		+			
	C080	<i>PARTY NAME</i>	C		+			
	C059	<i>STREET</i>	C		+			
	3164	CITY NAME	C	an..35	+			
	3229	COUNTRY SUB-ENTITY IDENTIFICATION	C	an..9	+			
	3251	POSTCODE IDENTIFICATION	C	an..9	+			
	3207	COUNTRY, CODED	C	an..3	'			
REST OF SEGMENT NOT USED.								

CODE VALUES

3039 - Party id. identification [NAD 1st and 2nd occurrence]

Individual notification by the Implementation Plant -> Code Value has to be in line with the information given in DELFOR/DELJIT.

3055 - Code list responsible agency, coded

16 DUN & Bradstreet (DUNS) **92**
Assigned by buyer or buyer's agent.

Note: For the Material Issuer DUNS (NAD:MI), they will be as follows:

US = 005356878

Mexico

265 = 812392157
266 = 812563302
268 = 812138881

0120 LOC - PLACE/LOCATION IDENTIFICATION

Segment group: 2 [NAD.LOC] Level: 2
EDIFACT status: conditional Nexteer status: conditional
Maximum use: 10 per preceding NAD Nexteer occurrences: 1 per segment group 2
Function: segment indicating more details regarding specific places/locations related to the party specified in the NAD segment, e.g. internal site/building number.

Nexteer interchange: the LOC segment must be sent after the NAD identifying the Ship-to address (qualifier value ST).

Example: **LOC+11+H301'** Use after NAD = ST segment
 A B

EDIFACT STANDARD DEFINITION						Nexteer IMPLEMENTATION			
REF	TAG	NAME	ST	FT	SP	ST	FT	REMARKS	
A	3227	PLACE/LOCATION QUALIFIER	M	an..3	+	M	an..3	"11" = Place/port of discharge.	
	C517	LOCATION IDENTIFICATION	C			C			
B	3225	Place/location identification	C	an..25	:	C	an..25	Code identifying the receiving dock at the plant. Suppliers should return the value that is sent in the DELJIT LOC.	
	1131	Code list qualifier	C	an..3					
	3055	Code list responsible agency, coded	C	an..3	:				
	3224	Place/location	C	an..70	+				
	C519	RELATED LOCATION ONE ID.	C						
	3223	Related place/location one Id.	C	an..25	:				
	1131	Code list qualifier	C	an..3	:				
	3055	Code list responsible agency, coded	C	an..3	:				
	3222	Related place/location one	C	an..70	+				
	C553	RELATED LOCATION TWO ID.	C						
	3233	Related place/location two Id.	C	an..25	:				
	1131	Code list qualifier	C	an..3	:				
	3055	Code list responsible agency, coded	C	an..3	:				
	3232	Related place/location two	C	an..70	+				
	5479	RELATION, CODED	C	an..3	'				

Segment group 6: TDT-PCD-SG7

Segment group: 6 Level: 1
 EDIFACT status: conditional Nexteer status: mandatory
 Maximum use: 10 per message at level 1 Nexteer occurrences: max. 2 per message
 Function: group of segments specifying details of the mode and means of transport and date/time of departure and destination relevant to the whole despatch advice. Nexteer interchange: only segment TDT is used in segment group 6.

0240 TDT - DETAILS OF TRANSPORT

Segment group: 6 [TDT] Level: 1
 EDIFACT status: mandatory if segment group 6 is used Nexteer status: mandatory
 Maximum use: 1 per segment group 6 (max. 10) Nexteer occurrences: 1 per segment group 6 Function: segment specifying the carriage, and the mode and means of transport of the goods being despatched. Nexteer interchange:

Example: **TDT+25++LT++HMES::182'**

A B C D FG H I J K

EDIFACT STANDARD DEFINITION						Nexteer IMPLEMENTATION		
REF	TAG	NAME	ST	FT	SP	ST	FT	REMARKS
A	8051	TRANSPORT STAGE QUALIFIER	M	an..3	+	M	an..3	For code value see below.
	8028	CONVEYANCE REFERENCE NR	C	an..17	+			
B	C220	MODE OF TRANSPORT	C			M		For code value see below.
	8067	Mode of transport, coded	C	an..3	:	M	an..3	
	8066	of transport	C	an..17	+			
	C228	TRANSPORT MEANS	C					
C	8179	Type of means of transport id.	C	an..8	:			
	8178	Type of means of transport	C	an..17	+			
	C040	CARRIER	C			M		
D	3127	Carrier identification	C	an..17	:	M	an..17	Valid SCAC code required.
	1131	Code list qualifier	C	an..3	:			
	3055	Code list responsible agency, coded	C	an..3	:	C	an..3	
	3128	Carrier name	C	an..35	+			For code value see below.
	8101	TRANSIT DIRECTION, CODED	C	an..3	+	C	an..3	Used only for Ship Direct. This value should be turned around from the DELFOR/DELJIT.
	C401	EXCESS TRANSPORTATION INFORMATION	C			C		Indication of the reason for excess transportation. For code values see below. Indication of responsibility for excess transportation. For code values see below. Transportation Authorization Number
	8457	Excess transportation reason, coded	M	an..3	:		an..3	
	8459	Excess transportation responsibility, coded	M	an..3	:		an..3	
	7130	Customer authorization number	C	an..17	+	C	an..17	
	C222	TRANSPORT IDENTIFICATION	C					
	8213	Id. of means of transport identification	C	an..9	:			
	1131	Code list qualifier	C	an..3	:			
	3055	Code list responsible agency, coded	C	an..3	:			
	8212	Id. of the means of transport	C	an..35	:			
	8453	Nationality of means of transport, coded	C	an..3	+			
	8281	TRANSPORT OWNERSHIP, CODED	C	an..3	'			

CODE VALUES

3055 - Code list responsible agency, coded

182 Standard Carrier Alpha Code (SCAC)

8051 - Transport stage qualifier

12 At departure
Transport by which goods are moved from the place of departure. Pick-up SCAC.

8067 - Mode of transport, coded

General Codes to be used for Nexteer, more detailed Codes may need to be implemented on request of Nexteer Implementation Plant:

- A** Air
- AC** Air Charter
- AE** Air Express
- C** Consolidation
- D** Parcel Post
- E** Expedited Truck
- FA** Air Freight Forwarder
- G** Piggyback
- GS** Progressive pick-up (milk run)
- H** Customer Pick-up
- J** Motor
- LT** Less than trailer load
- R** Rail
- SE** Sea/Air
- SR** Supplier Truck
- SS** Steamship **T** Best way
- TC** (Taxi) Cab
- U** Private Parcel Service
- VE** Vessel, Ocean
- W** Inland Waterway

Segment group 8: EQD-MEA-SEL-EQA-SG9

Segment group: 8 Level: 1
 EDIFACT status: conditional Nexteer status: mandatory
 Maximum use: 10 per message at level 1 Nexteer occurrences: max. 10 per message
 Function: group of segments providing information relative to the equipment used for the transportation of goods relevant to the whole despatch advice.
 Nexteer interchange: only segments EQD and SEL are used in segment group 8.

0300 EQD - EQUIPMENT DETAILS

Segment group: 8 [EQD] Level: 1
 EDIFACT status: mandatory if segment group 08 is used Nexteer status: mandatory
 Maximum use: 1 per segment group 8 (max. 10) Nexteer occurrences: 1 per segment group 8
 Function: segment to define fixed information regarding equipment used in conjunction with the whole despatch advice, and if required, to indicate responsibility for supply of the equipment. Nexteer interchange: see remarks.

Example: **EQD+TE+TRAILER 001'**
 A B

EDIFACT STANDARD DEFINITION						Nexteer IMPLEMENTATION		
REF	TAG	NAME	ST	FT	SP	ST	FT	REMARKS
A	8053	EQUIPMENT QUALIFIER	M	an..3	+	M	an..3	For code value see below.
B	C237	<i>EQUIPMENT IDENTIFICATION</i>	C			M		Used to identify equipment number, such as railcar or trailer number including initials.
	8260	Equipment identification number	C	an..17	:	M	an..17	
	1131	Code list qualifier	C	an..3	:			
	3055	Code list responsible agency, coded	C	an..3	:			
	3207	Country, coded	C	an..3	+			
	C224	<i>EQUIPMENT SIZE AND TYPE</i>	C					
	8155	Equipment size and type id.	C	an..10	:			
	1131	Code list qualifier	C	an..3	:			
	3055	Code list responsible agency, coded	C	an..3	:			
	8154	Equipment size and type	C	an..35	+			
8077	EQUIPMENT SUPPLIER, CODED	C	an..3	+				
8249	EQUIPMENT STATUS, CODED	C	an..3	+				
8169	FULL/EMPTY INDICATOR, CODED	C	an..3	'				

CODE VALUES

8053 - Equipment qualifier

- CN** Container
Equipment item as defined by ISO for transport. It must be of: A) permanent character, strong enough for repeated use; B) designed to facilitate the carriage of goods, by one or more modes of transport, without intermediate reloading; C) fitted with devices for its ready handling, particularly.
- RR** Railcar
Registered identification number of railway wagon
- TE** Trailer

A vehicle without motive power, designed for the carriage of cargo and to be towed by a motor vehicle.

Segment group 10: CPS-FTX-SG11-SG15

Segment group: 10 [CPS] Level: 1
 EDIFACT status: conditional Nexteer status: mandatory
 Maximum use: 9999 per message Nexteer occurrences: max 499 occurrences per msg.

Function: group of segments providing details of all package levels and of the individual despatched items contained in the consignment. This segment group provides the capability to give the hierarchical packing relationships. The group defines a logical top-down order structure. The lowest level package information of the hierarchy is followed by the detail product information.

0380 CPS - CONSIGNMENT PACKING SEQUENCE (7075 = 1)

Segment group: 10 [CPS] Level: 1
 EDIFACT status: mandatory if segment group 10 is used Nexteer status: mandatory
 Maximum use: 1 per segment group 10 (max.9999) Nexteer occurrences: max 499 occurrences per msg.

Function: segment identifying the sequence in which packing of the consignment occurs, e.g. boxes loaded onto a pallet.

Nexteer interchange: see remarks.

Example: **CPS+1++4'**
 A B

EDIFACT STANDARD DEFINITION					Nexteer IMPLEMENTATION			
A	7164	HIERARCHICAL ID. NUMBER	M	an..12	+	M	an..12	A unique number assigned by the sender to identify a level within a hierarchical structure. Begins with the number 1 and increments by one for each occurrence within the message. Numbers are not to be repeated within the same message.
	7166	HIERARCHICAL PARENT ID.	C	an..12	+			
B	7075	PACKAGING LEVEL, CODED	C	an..3	'	M	an..3	Use code value of '4' see below.

CODE VALUES

7075 - Packaging Level, Coded

4 There is no specifiable level of packaging: packaging is inner and outer level as well
Note: Use code 4 for Packaging level, Coded – 7075

Segment group 11: PAC-MEA-QTY-SG12-SG13

Segment group: 11 [CPS.QTY.SG11] Level: 2
 EDIFACT status: mandatory Nexteer status: mandatory
 Maximum use: 999 per CPS in segment group 10 Nexteer occurrences: 1 per segment group 10
 Function: group of segments identifying packaging, physical dimensions, marks and numbers, quantities, date and time information, handling information and information about packing at this level. Nexteer interchange: only the segments PAC and QTY are used in segment group 11.

0410 PAC - PACKAGE

Segment group: 11 [CPS.PAC] Level: 2
 EDIFACT status: mandatory if segment group 11 is used Nexteer status: mandatory
 Maximum use: 1 per segment group 11 (max. 9999 per CPS) Nexteer occurrences: 1 per segment group 11
 Function: segment specifying the number and type of the packages/physical units and the physical type of packaging for the despatched goods. Nexteer interchange:

Example: **PAC+8++PALLET'**
 A B

EDIFACT STANDARD DEFINITION					Nexteer IMPLEMENTATION			
A	7224	NUMBER OF PACKAGES	C	n..8	+	M	n..8	Number of packages.
	C531	PACKAGING DETAILS	C					
	7075	Packaging level, coded	C	an..3	:			
	7233	Packaging related information, coded	C	an..3	:			
	7073	Packaging terms and conditions, coded	C	an..3	+			
B	C202	PACKAGE TYPE	C			M		
	7065	Type of packages identification	C	an..17	:	M	an..17	Identification of the container used for the shipment of the part number identified in the following LIN segment.
	1131	Code list qualifier	C	an..3	:			
	3055	Code list responsible agency, coded	C	an..3	:			
	7064	Type of packages	C	an..35	+			
	C402	PACKAGE TYPE IDENTIFICATION	C					
	7077	Item description type, coded	M	an..3	:			
	7064	Type of packages	M	an..35	:			
	7143	Item number type, coded	C	an..3	:			
	7064	Type of packages	C	an..35	:			
	7143	Item number type, coded	C	an..3	+			
	C532	RETURNABLE PACKAGE DETAILS	C					
	8395	Returnable package freight payment responsibility, coded	C	an..3	:			

8393	Returnable package load contents, coded	C	an..3	'			
------	---	---	-------	---	--	--	--

Segment group 13: PCI-RFF-DTM-GIR-SG14

Segment group: 13 [CPS.PAC.SG13] Level: 3
 EDIFACT status: conditional Nexteer status: mandatory
 Maximum use: 1000 per PAC in segment group 11 Nexteer occurrences: as required Function: group of segments specifying markings, labels, and packaging numbers.
 Nexteer interchange: see segment description

0480 PCI - PACKAGE IDENTIFICATION

Segment group: 13 [CPS.PAC.PCI] Level: 3
 EDIFACT status: mandatory if segment group 13 is used Nexteer status: mandatory
 Maximum use: 1 per segment group 13 (max.1000 per CPS) Nexteer occurrences: 1 per segment group 13 Function: segment specifying marking and labels used on individual packages or a range of packages. Nexteer interchange: see remarks.
 Example: **PCI+16+0001'** Shipment based example

A B

EDIFACT STANDARD DEFINITION						Nexteer IMPLEMENTATION		
REF	TAG	NAME	ST	FT	SP	ST	FT	REMARKS
A	4233	MARKING INSTRUCTIONS, CODED	M	an..3	+	M	an..3	"16" = Buyer's instructions.
B	C210	MARKS & LABELS	C			M		Storage Location, sent in DELJIT
	7102	Shipping marks	M	an..35	:			
	7102	Shipping marks	C	an..35	:			
	7102	Shipping marks	C	an..35	:			
	7102	Shipping marks	C	an..35	:			
	7102	Shipping marks	C	an..35	:			
	7102	Shipping marks	C	an..35	:			
	7102	Shipping marks	C	an..35	:			
	7102	Shipping marks	C	an..35	:			
	7102	Shipping marks	C	an..35	+			
	8275	CONTAINER/PACKAGE STATUS, CODED	C	an..3	+			
	C827	TYPE OF MARKING	C					
	7511	Type of marking, coded	M	an..3	:			
	1131	Code list qualifier	C	an..3	:			
	3055	Code list responsible agency, coded	C	an..3	'			

Note: The value sent in DELJIT (PCI segment, with 11Z qualifier) should be returned in 7102 – Shipping marks.

Segment group 15: LIN-PIA-IMD-MEA-QTY-ALI-GIN-GIR-DLMDTM-NAD-TDT-HAN-FTX-MOA-SG16-SG17-SG18-SG19-SG20SG23

Segment group: 15 [CPS.SG15] Level: 2
 EDIFACT status: conditional Nexteer status: conditional
 Maximum use: 9999 Nexteer occurrences: Max of 499 per ASN
 Function: group of segments providing details of the individual despatched items.
 Nexteer interchange: only LIN, PIA, QTY and TDT are used in segment group 15.

0560 LIN - LINE ITEM

Segment group: 15 [CPS.LIN] Level: 2
 EDIFACT status: mandatory if segment group 15 is used Nexteer status: mandatory
 Maximum use: 1 per segment group 15 (max. 9999 per CPS) Nexteer occurrences: 1 per segment group 15
 Function: segment identifying the product being despatched. All other segments in the detail section following the LIN segment refer to that line item.

Nexteer interchange:

Example: **LIN+++123ABC99:IN'** **Customer PN reference**
 A B

EDIFACT STANDARD DEFINITION					Nexteer IMPLEMENTATION			
	1082	LINE ITEM NUMBER	C	n..6	+	C	n..6	
	1229	ACTION REQUEST/ NOTIFICATION, CODED	C	an..3	+			
A	C212	ITEM NUMBER IDENTIFICATION	C			M		
B	7140	Item number	C	an..35	:	M	an..35	Nexteer assigned part number.
	7143	Item number type, coded	C	an..3	:	M	an..3	"IN" = Buyer's item number.
	1131	Code list qualifier	C	an..3	:			
	3055	Code list responsible agency, coded	C	an..3	+			
	C829	SUB-LINE INFORMATION	C					
	5495	Sub-line indicator, coded	C	an..3	:			
	1082	Line item number	C	n..6	+			
	1222	CONFIGURATION LEVEL	C	n..2	+			
	7083	CONFIGURATION, CODED	C	an..3	'			

CODE VALUES

7143 – Item Number Type, Coded

IN Buyer's Item Number. **VP**
Customer's Item Number

*****Item number can NOT be entered more than once on a single ASN*****

***** A maximum of 499 line items are permitted per ASN *****

0570 PIA - ADDITIONAL PRODUCT ID

Segment group: 15 [CPS.LIN.PIA] Level: 3
 EDIFACT status: conditional Nexteer status: conditional
 Maximum use: 10 per LIN in segment group 15 Nexteer occurrences: 1 per preceding LIN
 Function: segment providing additional product identification.

Example: **PIA+1+B:EC+12345:AP+56789:BB**
 A B C

EDIFACT STANDARD DEFINITION						Nexteer IMPLEMENTATION		
REF	TAG	NAME	ST	FT	SP	ST	FT	REMARKS
A	4347	PRODUCT ID. FUNCTION QUALIFIER	M	an..3	+	M	an..3	"1" = Additional identification
	C212	ITEM NUMBER IDENTIFICATION	M			M		
B	7140	Item number	C	an..35	:	M	an..35	Identification of the Revision Level*
C	7143	Item number type, coded	C	an..3	:	M	an..3	"EC" = Revision level
	1131	Code list qualifier	C	an..3	:			
	3055	Code list responsible agency, coded	C	an..3	+			
	C212	ITEM NUMBER IDENTIFICATION	C			M		
	7140	Item number	C	an..35	:	M	an..35	Identification of the Heat code for Steel*
	7143	Item number type, coded	C	an..3	:	M	an..3	"AP" = Heat code Number
	1131	Code list qualifier	C	an..3	:			
	3055	Code list responsible agency, coded	C	an..3	+			
	C212	ITEM NUMBER IDENTIFICATION	C			M		
	7140	Item number	C	an..35	:	M	an..35	Identification of the Lot Number*
	7143	Item number type, coded	C	an..3	:	M	an..3	"BB" = Lot Number
	1131	Code list qualifier	C	an..3	:			
	3055	Code list responsible agency, coded	C	an..3	+			

C212	ITEM NUMBER IDENTIFICATION	C						
7140	Item number	C	an..35	:				
7143	Item number type, coded	C	an..3	:				
1131	Code list qualifier	C	an..3	:				
3055	Code list responsible agency, coded	C	an..3	+				
C212	ITEM NUMBER IDENTIFICATION	C						
7140	Item number	C	an..35	:				
7143	Item number type, coded	C	an..3	:				
1131	Code list qualifier	C	an..3	:				
3055	Code list responsible agency, coded	C	an..3	+				

*Engineering Change/Revision Level is NOT provided on the DELJIT.

0600 QTY - QUANTITY

Segment group: 15 [CPS.LIN.QTY] Level: 3
 EDIFACT status: conditional Nexteer status: mandatory
 Maximum use: 10 per preceding LIN Nexteer occurrences: max. 2 per segment group 15

Function: segment to give quantity information concerning the product.
 Nexteer interchange: see remarks.

Example: QTY+3:2880:PC'
 QTY+12:14400:PC'
 A B C

EDIFACT STANDARD DEFINITION						Nexteer IMPLEMENTATION		
REF	TAG	NAME	ST	FT	SP	ST	FT	REMARKS
Cumulative quantity shipped since start of inventory year						Mandatory		
	C186	QUANTITY DETAILS	M			M		
A	6063	Quantity qualifier	M	an..3	:	M	an..3	"3" = Cumulative quantity. Cumulative quantity of the part identified in the preceding LIN, shipped since start of inventory year by this supplier to this plant. (3 decimal positions allowed)
B	6060	Quantity	M	n..15	:	M	n..12	

C	6411	Measure unit qualifier	C	an..3	'	C	an..3	For code value see UN/ECE Recommendation no. 20. (This must be the same Unit of Measure provided on the corresponding shipment authorization document DELFOR/DELJIT.)
---	------	------------------------	---	-------	---	---	-------	---

Despatch quantity			Mandatory					
	C186	QUANTITY DETAILS	M			M		
A	6063	Quantity qualifier	M	an..3	:	M	an..3	"12" = Despatch quantity Actual quantity as defined in 6063 above. (3 decimal positions allowed) For code value see UN/ECE Recommendation no. 20. (This must be the same Unit of Measure provided on the corresponding shipment authorization document DELFOR/DELJIT.)
B	6060	Quantity	M	n..15	:	M	n..12	
C	6411	Measure unit qualifier	C	an..3	'	C	an..3	

Segment group 16: RFF-NAD-CTA-DTM

Segment group: 16 □CPS.LIN.SG16□ Level: 3
 EDIFACT status: conditional Nexteer status: mandatory
 Maximum use: 99 per LIN in segment group 15 Nexteer occurrences: 1 per segment group 15 Function: group of segments to give reference numbers and dates. Nexteer interchange: only RFF is used in segment group 16.

0720 RFF - REFERENCE

Segment group: 16 [SEQ.LIN.RFF] Level: 3
 EDIFACT status: mandatory if segment group 16 is used Nexteer status: mandatory
 Maximum use: 1 per segment group 16 (max.99 per LIN) Nexteer occurrences: 2 per segment group 16 Function: segment identifying documents related to the line item. Nexteer interchange: see remarks.

Example: **RFF+ON:9011234'**
 A B

EDIFACT STANDARD DEFINITION					Nexteer IMPLEMENTATION			
	C506	<i>REFERENCE</i>	M			M		
A	1153	Reference qualifier	M	an..3	:	M	an..3	See list
B	1154	Reference number	C	an..35	:	C	an..35	Number of the Purchase Order relevant for the article defined in the preceding LIN.
	1156	Line number	C	an..6	:	C	an..6	Item line number from the Purchase Order
	4000	Reference version number	C	an..35	:			

1153 – Reference Number

ON Order Number

SAMPLE DESADV MESSAGE – Shipment Based

The following example is only illustrative and may not reflect an existing situation as either a test or production transmission.

US DESADV Example

UNB+UNOA:2+QQQ:ZZ+NEXTEERNA:ZZ+120322:1503+233++DESADV'
 UNH+4+DESADV:D:97A:UN'
 BGM++605124+9'
 DTM+137:201203221503:203'
 DTM+11:201203221500:203'
 MEA+AAX+G+LBR:200'
 MEA+AAX+N+LBR:180'
 MEA+AAX+SQ+EA:1'
 RFF+MB:605124'
 RFF+CN:124578962345AB'

 NAD+MI+005356878::16'
 NAD+ST+07::92'
 LOC+11+07'
 NAD+SU+068123897::16'
 TDT+12++LT++HMES::182'
 EQD+TE+5432189'

 CPS+1++4'
 PAC+1++PALLET'
 PCI+16+ A-04'
 LIN+++26066615:IN'
 PIA+1+03:EC'
 QTY+3:20500:PC'
 QTY+12:100:PC'
 RFF+ON:9011234'
 UNT+24+4'
 UNZ+1+233'

**Supplier Mailbox ID; Nexteer Mailbox ID:ZZ*
Document Type, Version
Shipment Identification Number (Same as Packing Slip #)
Document issue date/time
Dispatch date/time
Shipment gross weight
Shipment net weight
Total number of Lading units
Master Bill of Lading (Packing Slip Number)
Carrier Reference Number (Pro Number)
Nexteer DUNS number(may differ per location or division)

Ship to location code
Delivery dock from DELJIT
Supplier DUNS number
Details of transport; Carrier SCAC code
Equipment Identification
Packaging details of first part number Use '4' no specific Level of packaging
Packing details of first part number
Deliver Location (DLOC) from DELJIT
First part number
EC =Revision Level AP = Heat Number BB = Lot Number
Cumulative shipped quantity to include current shipment
Actual shipped quantity
Purchase Order number
Segment count, UNH through UNT inclusive
Message count

Nexteer Mexico DESADV Example

UNB+UNOA:2+QQQ:ZZ+NEXTEERM:ZZ+120322:1503+233++DESADV'	<i>*Supplier Mailbox ID; Nexteer Mailbox ID:ZZ</i>
UNH+4+DESADV:D:97A:UN'	<i>Document Type, Version</i>
BGM++605124+9'	<i>Shipment Identification Number (Same as Packing Slip #)</i>
DTM+137:201203221503:203'	<i>Document issue date/time</i>
DTM+11:201203221500:203'	<i>Dispatch date/time</i>
MEA+AAX+G+LBR:200'	<i>Shipment gross weight</i>
MEA+AAX+N+LBR:180'	<i>Shipment net weight</i>
MEA+AAX+SQ+EA:1'	<i>Total number of Lading units</i>
RFF+MB:605124'	<i>Master Bill of Lading (Packing Slip Number)</i>
RFF+CN:124578962345AB'	<i>Carrier Reference Number (Pro Number)</i>
NAD+MI+812392157::16'	<i>Nexteer DUNS number(may differ per location or division)</i>
NAD+ST+265::92'	<i>Ship to location code</i>
LOC+11+265'	<i>Delivery dock from DELJIT</i>
NAD+SU+068123897::16'	<i>Supplier DUNS number</i>
TDT+12++LT++HMES::182'	<i>Details of transport; Carrier SCAC code</i>
EQD+TE+5432189'	<i>Equipment Identification</i>
CPS+1++4'	<i>Packaging details of first part number Use '4' no specific</i>
PAC+1++PALLET'	<i>Level of packaging</i>
PCI+16+ A-04'	<i>Packing details of first part number</i>
LIN+++26066615:IN'	<i>Deliver Location (DLOC) from DELJIT</i>
PIA+1+03:EC'	<i>First part number</i>
QTY+3:20500:PC'	<i>EC =Revision Level AP = Heat Number BB = Lot Number</i>
QTY+12:100:PC'	<i>Cumulative shipped quantity to include current shipment</i>
RFF+ON:9011234'	<i>Actual shipped quantity</i>
UNT+24+4'	<i>Purchase Order number</i>
UNZ+1+233'	<i>Segment count, UNH through UNT inclusive</i>
	<i>Message count</i>

For purposes of readability, the message has been shown with each segment on a separate line. This will not be the case when the message is normally transmitted.

SAMPLE DESADV MESSAGE – Shipment Based

The following example is only illustrative and may not reflect an existing situation as either a test or production transmission.

UNB+UNOA:2+QQQ:ZZ+NEXTEERNA:ZZ+120322:1503+233++DESADV'	*Supplier Mailbox ID; Nexteer Mailbox ID:ZZ
UNH+4+DESADV:D:97A:UN'	Document Type, Version
BGM++605124+9'	Shipment Identification Number (Same as Packing Slip #)
DTM+137:201203221503:203'	Document issue date/time
DTM+11:201203221500:203'	Dispatch date/time
MEA+AAX+G+LBR:200'	Shipment gross weight
MEA+AAX+N+LBR:180'	Shipment net weight
MEA+AAX+SQ+EA:1'	Total number of Lading units
RFF+MB:605124'	Master Bill of Lading (Packing Slip Number)
RFF+CN:124578962345AB'	Carrier Reference Number (Pro Number)
NAD+MI+005356878::16'	Nexteer DUNS number(may differ per location or division)
NAD+ST+07::92'	005356878 = NA
LOC+11+07'	Ship to location code
NAD+SU+068123897::16'	Delivery dock from DELJIT
TDT+12++LT++HMES::182'	Supplier DUNS number
EQD+TE+5432189'	Details of transport; Carrier SCAC code
CPS+1++ 4 '	Equipment Identification
PAC+1++PALLET'	Packaging details of first part number Use '4' no specific Level of packaging
PCI+16+ A-04 '	Packaging details of first part number
LIN+++26066615:IN'	Deliver Location (DLOC) from DELJIT
PIA+1+03:EC+12345:AP'	First part number
PIA+1+03:EC+12347:AP'	EC =Revision Level AP = Heat Number BB = Lot Number
PIA+1+03:EC+12350:AP'	EC =Revision Level AP = Heat Number BB = Lot Number
QTY+3:20500:PC'	EC =Revision Level AP = Heat Number BB = Lot Number
QTY+12:100:PC'	Cumulative shipped quantity to include current shipment
RFF+ON:9011234'	Actual shipped quantity
UNT+24+4'	Purchase Order number
UNZ+1+233'	Segment count, UNH through UNT inclusive
	Message count

Values **bolded** in the above sample DESADV message are examples of values from the segments that must be returned from the corresponding DELJIT. The table below describes these segments and the segments that are to be returned from the DELJIT. For purposes of eliminating redundancy, only values in the first message are bolded and described below.

DELJIT Segment	DELJIT Example:	DESADV Segment	DESADV Example:
NAD+MI	NAD+MI+005356878::16'	NAD+MI	NAD+MI+005356878::16'
NAD+SU	NAD+SU+068123897::16++SUPPLIER NAME'	NAD+SU	NAD+SU+068123897::16'
NAD+ST	NAD+ST+07::16++ NEXTEER AUTOMOTIVE'	NAD+ST	NAD+ST+07::92'
PCI.....11Z	PCI++++11Z:A-04:167'	PCI+16	PCI+16+A-04'
LIN	LIN+++123ABC99:IN'	LIN	LIN+++123ABC99:IN'
RFF+ON	RFF+ON:90I1234	RFF+ON	RFF+ON:90I1234
LOC	LOC+11+07'	LOC	LOC+11+07'